

HEAT PUMP COMPARISON

BWT heat pumps

Heating power (Air at 15°C and Water at 26°C)

Inverter technology

Zubadan technology

(very low power loss when outside temperatures drop)

Defrosting by cycle inversion

Air blowing

Operating temperature range

Maximum set point temperature in heating mode

Minimum set point temperature in cooling mode

WIFI control

Wired-in remote control

Heat exchanger

Casing

Refrigerant

Compatible with a 60 Hz power supply

Heat pump guarantee

Titanium heat exchanger guarantee

Compressor guarantee



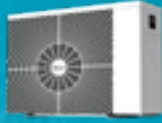

**BWT Mitsubishi
Zubadan (MZI)**

**BWT Mitsubishi
Power Inverter (MPI)**

**BWT Inverter
horizontal**

**BWT Inverter
vertical**

Pioneer Inverter

	17 to 33 kW	10.6 to 39 kW	5 to 24.5 kW	10 to 20 kW	6 to 14 kW
	Yes	Yes	Yes	Yes	Yes
	Yes	No	No	No	No
	Yes	Yes	Yes	Yes	Yes
	Horizontal	Horizontal	Horizontal	Vertical	Horizontal
	-15°C to 46°C	-15°C to 46°C	0°C to 43°C	0°C to 43°C	7°C to 43°C
	38°C	38°C	40°C	40°C	40°C
	8°C	8°C	12°C	12°C	12°C
	No	No	Yes	Yes	Yes
	Option (20 m cable)	Option (20 m cable)	Option (10 m cable)	Option (10 m cable)	Option (10 m cable)
	Titanium	Titanium	Titanium and PVC	Titanium and PVC	Titanium and PVC
	Painted, galvanised sheet metal	Painted, galvanised sheet metal	Aluminium with ceramic treatment	Aluminium with ceramic treatment	Painted, galvanised sheet metal
	R410A	R410A	R32	R32	R32
	Yes	Yes	Yes	Yes	No
	5 years	5 years	3 years	3 years	2 years
	10 years	10 years	Lifetime	Lifetime	5 years
	5 years	5 years	10 years	10 years	3 years



+ The industrial strength of a world leader

Mitsubishi Electric, a world leader in the field of heat pumps for climate control and heating, have produced several million machines that use Ecodan Power Inverter and Zubadan Power Inverter technologies. These machines are renowned for their reliability and excellent performance levels.

Mitsubishi and Procopi decided to pool their core expertise to create two ranges of swimming pool heat pumps, the M.P.I. (Ecodan) range and the M.Z.I. (Zubadan) range.



BWT Power Inverter M.P.I. and M.Z.I. heat pumps exploit these technologies to achieve exceptional performance levels, both in terms of noise level and improved coefficient of performance.

Comprehensive range

The BWT Power Inverter range offers a selection of models to suit pools of all types and sizes.

Inverter system

On the contrary to a conventional On/Off heat pump that run at a constant speed (50 Hz), the Inverter heat pump compressor can run at between 11 and 100 Hz to adapt to the machine's operating conditions and the outdoor temperature.

In fact, while the outside temperature is low, or while the heating demand is high, the compressor will run at high speed (between 50Hz and 100Hz).

Inversely, while the heating demand is low, notably around the set point, the Inverter compressor will run at low speeds (between 11Hz and 50Hz).

BWT M.P.I. and M.Z.I. heat pumps automatically adjust their compressor speed to adapt to the operating mode and outdoor temperature. There is no need for any intervention by the user.

Running at low speeds, inverter compressors are almost noiseless, provide optimal yield and enjoy a longer service life.

Reversible heat pumps

All BWT Power Inverter heat pumps are reversible as standard

BWT Power Inverter heat pumps can be used to heat or cool pool water, they are also compatible with systems running on 60 Hz.

This feature is particularly appreciated in very hot regions where it can be used to hold swimming pool water at a comfortable temperature or even to lower or maintain the water temperature in aquaculture tanks used to rear and store fish.

Silence

Conventional On/Off heat pumps generate a constant sound power, even when water temperature is around the set point.

On the other hand, BWT Power Inverter heat pump compressors slow significantly around the set point so that they run much more quietly than a conventional On/Off machine.

This is particularly important when the heat pump must be installed close to neighbouring properties.

Installers should take regulations governing neighbourhood noise abatement in effect in the country of installation into consideration.

Start-up overcurrents

BWT Power Inverter heat pumps feature acceleration ramps that exploit frequency variation technology to avoid overcurrents on start-up along with their inherent negative impact on electrical and electronic devices in the home.

Completely automated

BWT Power Inverter heat pumps are designed to be easy to install and simple to maintain.

Systematic quality control

To guarantee complete reliability, all BWT MPI and MZI heat pumps are tested before being shipped.

+ INNOVATION:

Procopi has developed a new geometry for the titanium exchangers equipping BWT MPI and MZI heat. Two gas injection baffles greatly improve the exchange between the primary and secondary circuits, to the point where the machines' power has been increased by 8% and their COP by 18%. In addition, the new design of the spiral plates cuts load losses in half



+ BWT TOP TIP



Our heating offer for commercial pools is listed in the Commercial Pool and spa chapter

HEAT PUMP TYPE

Outdoor temperature	On/Off	Power Inverter (MPI)	Zubadan (MZI)
15°C	100%	100%	100%
12°C	91%	94%	94%
7°C	79%	82%	84%
-7°C	-	58%	81%
-10°C	-	52%	77%
-15°C	-	44%	71%

The table above summarises the % heating capacity of the various air/ water swimming pool heat pumps at a range of outdoor air temperatures.



BWT Mitsubishi Zubadan Inverter (M.Z.I.) heat pumps share many of the characteristics of the BWT M.P.I. heat pump.

However, on the contrary to conventional On/Off heat pumps, a M.Z.I. heat pump can provide 80% of its heating capacity when the outdoor ground temperature is far below zero.

BWT M.Z.I. heat pumps are real all season machines specifically intended for indoor pools that are used year round and that require a constant nominal heating power.

Operating principle

BWT M.Z.I. heat pumps compensate for extremely low outdoor air temperatures by injecting hot gas from an additional bottle directly at the compressor.

Technical specifications

- Improved heat pump and COP (coefficient of performance).
- Reversible machine, may be used to cool the pool,
- The pool water temperature, set point and heat or cool operating mode are displayed on the remote control.
- Automatic defrosting by cycle inversion, the heat pump runs at temperatures down to -15°C.



The vibration damping pads are not included.

	BWT M.Z.I.-160M	BWT M.Z.I.-190M	BWT M.Z.I.-190T	BWT M.Z.I.-320T
Certified heating power, Air temp 26° C, Water temp 26° C	26 kW	31.4 kW	31.4 kW	50 kW
Certified heating power, Air temp 15° C, Water temp 26° C	17 kW	20.2 kW	20.2 kW	33 kW
Certified cooling power, Air temp 35° C, Water temp 28° C	13.00 kW	19.5 kW	19.5 kW	35.2 kW
Operating temperature range	From -15°C to 46°C			
Type of refrigerant	R 410A	R 410A	R 410A	R 410A
Recommended water flow rate	4 to 6 m ³ /h	5 to 7 m ³ /h	5 to 7 m ³ /h	10 to 12 m ³ /h
Maximum current consumed	30 A	35 A	13 A	26 A
Power supply	230 V 1ph	230 V 1ph	400 V 3ph	400 V 3ph
Power cable cross section	3 × 6 mm ²	3 × 10 mm ²	5 × 2.5 mm ²	5 × 6 mm ²
Electrical protection	32 A	40 A	16 A	32 A
Exchanger model	Helical plate	Helical plate	Helical plate	Helical plate
Compressor	Rotary	Scroll	Scroll	Scroll
Quantity of refrigerant	5.50 Kg	5.50 Kg	5.50 Kg	7.10 Kg
Number of fans	2	2	2	2
Dimension L x D x H (mm)	1250×360×1350	1250×360×1350	1250×360×1350	1250×360×1340
Weight	127 Kg	127 Kg	141 Kg	155 Kg
Code	11014005	11020005	11020105	11030105
Price	8,510.00	9,360.00	9,650.00	15,510.00

Selecting the right heat pump is a complicated process, many factors need to be taken into consideration (location, period of use, desired temperature, etc.). To correctly size your heat pump, carry out a heating study on www.procopi.com



The AFNOR ACP 90-327 agreement and the test standard drawn up by CERTITA, in the context of NF Pool-heat pump certification, recommend communication of the heating capacity at an outdoor temperature of 15°C.



Technical specifications

- Improved heat pump and COP (coefficient of performance),
- Reversible machine, can be used to heat or chill the pool, compatible with a 60 Hz operating regime,
- The pool water temperature, set point and heat or cool operating mode are displayed on the remote control,
- Automatic defrosting by cycle inversion, the heat pump runs at temperatures down to -15°C,
- Complies with EC standards,
- Low acoustic power in low speed mode, thanks to the Mitsubishi scroll inverter compressor,
- Titanium helical plate heat exchangers (Procopi exclusive), compatible with salt electrolysis. The plates features bosses that prevent the phenomenon of laminar flow and substantially increase the heat exchange capacity,
- Low water level safety device (flow switch),
- Wired in via a watertight deck box,
- Anti-UV treated ABS casing allowing integration of a regulator, deck box, heat exchanger, flow controller, sensors, communication and control circuit boards.
- Hydraulic connections, Ø 50 mm, solvent,
- ICHILL thermostat, comfort and Eco mode.
- Condensate collection and drainage kit.

Trophée d'Or 2013
Innovation category



Titanium exchanger



ICHILL thermostat



TECHNICAL DATA - BWT M.P.I.

	BWT M.P.I.-100M	BWT M.P.I.-160M	BWT M.P.I.-190M	BWT M.P.I.-190T	BWT M.P.I.-240M	BWT M.P.I.-240T	BWT M.P.I.-320T	BWT M.P.I.-380T
Certified heating power, Air temp 26° C, Water temp 26° C	16.2 kW	26 kW	31.4 kW	31.4 kW	39 kW	39 kW	50 kW	59 kW
Certified heating power, Air temp 15° C, Water temp 26° C*	10.6 kW	17 kW	20.2 kW	20.2 kW	25.5 kW	25.5 kW	33 kW	39 kW
Certified cooling power, Air temp 35° C, Water temp 28° C	5.7 kW	13 kW	19.5 kW	19.5 kW	20.25 kW	20.25 kW	35.2 kW	36.5 kW
Type of refrigerant	R 410A	R 410A	R 410A	R 410A	R 410A	R 410A	R 410A	R 410A
Recommended water flow rate	4 to 5 m ³ /h	4 to 6 m ³ /h	5 to 7 m ³ /h	5 to 7 m ³ /h	8 to 10 m ³ /h	8 to 10 m ³ /h	10 to 12 m ³ /h	12 to 14 m ³ /h
Maximum current consumed	13 A	19 A	29.5 A	13 A	29.5 A	13 A	19 A	21 A
Power supply	230 V 1ph	230 V 1ph	230 V 1ph	400 V 3ph	230 V 1ph	400 V 3ph	400 V 3ph	400 V 3ph
Power cable cross section	3 × 2.5 mm ²	3 × 4 mm ²	3 × 6 mm ²	5 × 2.5 mm ²	3 × 6 mm ²	5 × 2.5 mm ²	5 × 6 mm ²	5 × 6 mm ²
Electrical protection	16 A	25 A	32 A	16 A	32 A	16 A	32 A	32 A
Exchanger model	Helical plate	Helical plate	Helical plate	Helical plate	Helical plate	Helical plate	Helical plate	Helical plate
Compressor	Rotary	Rotary	Scroll	Scroll	Scroll	Scroll	Scroll	Scroll
Quantity of gas	2.10 Kg	3.20 Kg	4.60 Kg	4.60 Kg	4.60 Kg	4.60 Kg	7.10 Kg	7.70 Kg
Number of fans	1	1	2	2	2	2	2	2
Dimension L x D x H (mm)	995×495 x600	1150×360 x950	1250×360 x1350	1250×360 x1350	1250×360 x1350	1250×360 x1350	1250x 360 x1340	1250×360 x1340
Weight	49 Kg	82 Kg	125 Kg	125 Kg	125 Kg	137 Kg	142 Kg	148 Kg
Code	11010000	11014000	11020000	11020100	11026000	11026100	11032100	11038100
Price	5,520.00	6,910.00	8,010.00	8,350.00	9,250.00	9,510.00	10,770.00	12,030.00

* Technical data was certified by CETIAT and were measured according to the test protocol EN-14511 (Test report available from Procopi.com)..

Selecting the right heat pump is a complicated process, many factors need to be taken into consideration (location, period of use, desired temperature, etc.). To correctly size your heat pump, carry out a heating study on www.procopi.com

 The AFNOR ACP 90-327 agreement and the test standard drawn up by CERTITA, in the context of NF Pool-heat pump certification, recommend communication of the heating capacity at an outdoor temperature of 15°C.

			BWT M.P.I. 100M	BWT M.P.I. 160M	BWT M.P.I. 190M 190T	BWT M.P.I. 240M 240T	BWT M.P.I. 320T	BWT M.P.I. 380T	BWT M.Z.I. 160M	BWT M.Z.I. 190M 190T	BWT M.Z.I. 320T
Low Speed	STEP 1 : 20 Hz	COP*	8.51	8.14	7.69	7.20	6.95	6.84	8.14	7.69	6.95
		Acoustic pressure level at 10 m, in dB (Lp)	24	29	27	30	34	34	30	31	35
		Acoustic power, in dB (Lw)	52.8	57.9	55.8	58.7	62.9	62.9	57.9	58.7	62.9
Cruising speed	STEP 4 : 50 Hz	COP*	7.06	6.95	6.54	6.12	5.84	5.75	6.95	6.54	5.84
		Acoustic pressure level at 10 m, in dB (Lp)	28	33	29	34	39	39	34	35	39
		Acoustic power, in dB (Lw)	56.5	61.9	57.8	62.8	67.3	67.3	61.9	62.8	67.3
High speed	STEP 7 : 100 Hz	COP*	5.72	5.44	5.15	4.84	4.68	4.60	5.44	5.15	4.68
		Acoustic pressure level at 10 m, in dB (Lp)	35	40	40	43	47	47	41	42	47
		Acoustic power, in dB (Lw)	63	69	68.6	72	76	76	69.0	70.0	75.0

* COP is quoted for the following operating conditions: Air temp 15°C and water temp 26°C

The table below summarises the main characteristics of the BWT M.P.I. and M.Z.I. heat pumps in their various operating modes.

The heat pumps automatically select the operating mode best suited to the current weather and operating conditions.

- Low speed: BWT M.P.I. and M.Z.I. heat pumps can operate at three speeds below 50 Hz (Step 1, 2 and 3). The heat pump operates in this mode when it is close to the set point (within approximately 1°C). At these speeds, M.P.I. and M.Z.I. heat pumps offer a COP and sound levels that cannot be achieved by conventional On/ Off heat pumps.
- Cruising speed: This is the operating speed of a standard On/ Off heat pump, it corresponds to a compressor speed of 50 Hz, or Step 4.
- Full speed: BWT M.P.I. and M.Z.I. heat pumps operate at one of three speeds greater than 50 Hz (Steps 5, 6 and 7) during the initial heating ramp or when weather conditions are harsh.

BWT M.P.I. & M.Z.I. HEAT PUMP GUARANTEE CONDITIONS

Duration of the guarantee

BWT – Mitsubishi Power inverter heat pumps (M.P.I. and M.Z.I. models) are covered by a 5 year guarantee as of the date of invoice. The clauses and conditions constituting the heat pump guarantees may be found on our internet site. The guarantee period is extended to 10 years for the titanium exchanger.

BWT INVERTER HORIZONTAL

Family 5355

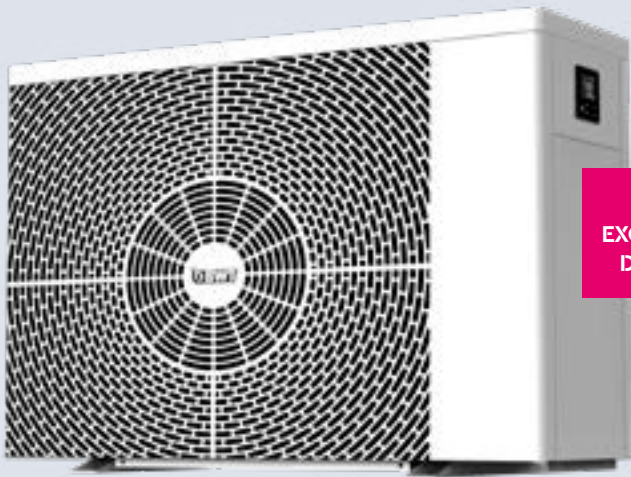

NEW EXCLUSIVE DESIGN



+  Only heat pumps bearing the Fairland brand can claim the Fairland performance levels and guarantees certified by the TÜV Rheinland



Twisted, titanium coil fitted in the heat pump exchanger

+ Vibration damping pads are included.

+ A ceramic coating to ensure that your heat pump keeps its looks. BWT heat pumps are coated with an additional, protective ceramic coating. Water-repellent and UV stable, it prevents oxidation and staining by dirt or chemicals. Well protected, BWT heat pumps are easy to clean, and remain gleaming, smooth and beautiful for a very long time.

TOUCH SCREEN CONTROL PAD FOR BWT INVERTER HORIZONTAL HEAT PUMPS



WiFi MODULE FOR FOR BWT INVERTER HORIZONTAL HEAT PUMPS

1. Access the support service in one click
2. Real time monitoring of your data
3. Wherever you are, whatever the time, you have control



+ The WiFi module is included as standard BWT Inverter horizontal heat pumps.

+ Caution, to use the WiFi module, the heat pump must be installed in a zone within the home that has WiFi coverage.

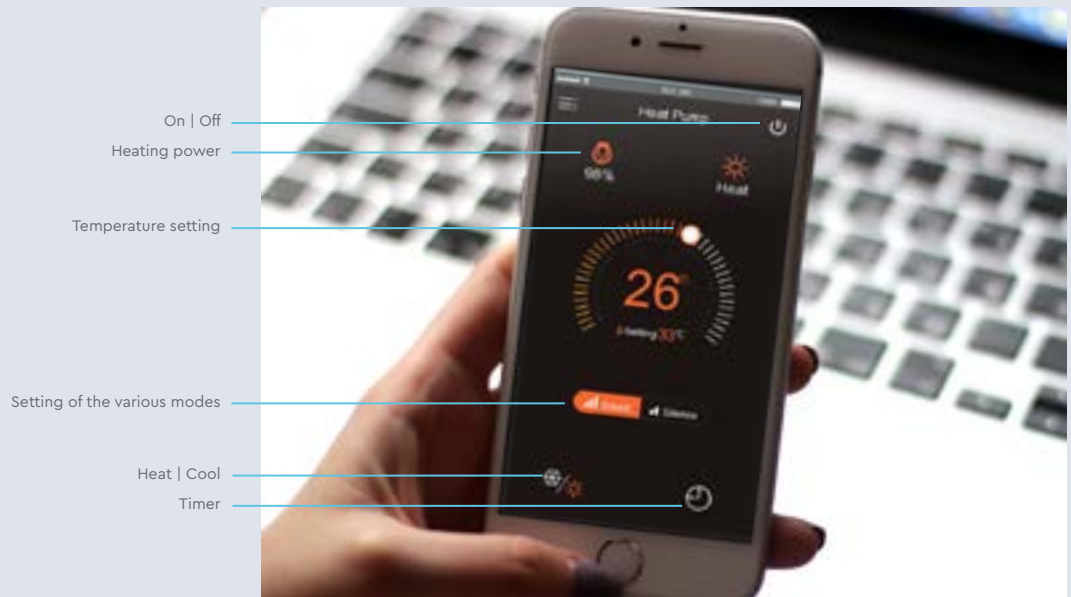

Comprehensive range

The BWT Inverter Horizontal range offers a selection of models to suit pools of all types and sizes. There is no need for any intervention by the user.

Inverter system

On the contrary to a conventional On/Off heat pump that run at a constant speed (100%), the Inverter heat pump compressor can run at between 20% and 100% to adapt to the machine's operating conditions and outdoor temperatures.

In fact, while the outside temperature is low, or while the heating demand is high, the compressor will run at high speed (between 50% and 100%).

Inversely, while the heating demand is low, notably around the set point, the Inverter compressor will run at low speeds (between 25% and 50%).

BWT Inverter horizontal heat pumps automatically adjust their compressor speed to adapt to the operating mode and outdoor temperature. There is no need for any intervention by the user.

Running at low speeds, inverter compressors are almost noiseless, provide optimal yield and enjoy a longer service life.

Reversible heat pumps

All BWT Inverter horizontal heat pumps are reversible as standard. BWT Inverter horizontal heat pumps can be used to heat or cool pool water.

This feature is particularly appreciated in very hot regions where it can be used to hold swimming pool water at a comfortable temperature or even to lower or maintain the water temperature in aquaculture tanks used to rear and store fish.

Silence

Conventional On/Off heat pumps generate a constant sound power, even when water temperature is around the set point.

On the other hand, BWT Inverter horizontal heat pump compressors

slow significantly around the set point so that they run much more quietly than a conventional On/Off machine

This is particularly important when the heat pump must be installed close to neighbouring properties.

Installers should take regulations governing neighbourhood noise abatement in effect in the country of installation into consideration

Start-up overcurrents

BWT Inverter horizontal heat pumps feature acceleration ramps that exploit frequency variation technology to avoid overcurrents on start-up along with their inherent negative impact on electrical and electronic devices in the home.

Completely automated

BWT Inverter horizontal heat pumps are designed to be easy to install and simple to maintain.

Aluminium cabinet

A modern and innovative design in aluminium, completely resistant to corrosion over .

Systematic quality control

To guarantee complete reliability, all BWT Inverter horizontal heat pumps are tested before being shipped.

Equipment

BWT Inverter horizontal heat pumps are delivered with a winter jacket.

Guarantees

BWT Inverter horizontal heat pump titanium exchangers are covered by a ten year guarantee, the compressor is covered by a ten year guarantee.

Repairs made under this guarantee are carried out on site.

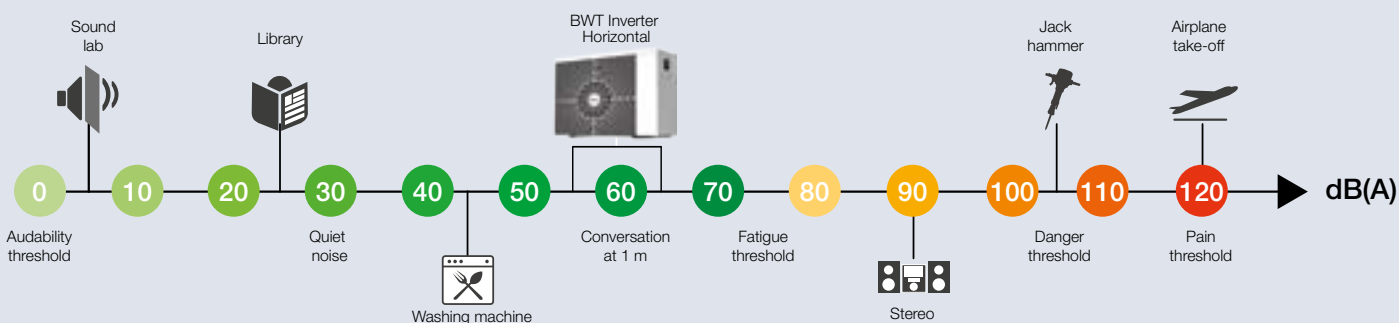

The scale above compare the acoustic power level of BWT Inverter horizontal with every events.



The R32 refrigerant offers numerous advantages:

- It outperforms the R410A refrigerant by 5% to 10%
- Requires less fluid for an identical output power (20 to 30% less fluid compared to R410A)
- It is more environmentally friendly. R32 has a Global Warming Potential (GWP-

indicates the impact a fluid has on global warming) of 675, compared to 2088 for R410A.

- Given its low GWP, leaktightness tests are only mandatory for loads greater than 7.2 kg (compared to 2.82 kg for R410C and 2.39 kg for R410A)
- R32 is totally pure and therefore, very easy to recycle.

	HI-HC 66	HI-HC 85	HI-HC 106	HI-HC 132	HI-HC 150	HI-HC 177	HI-HC 204	HI-HC 273	HI-HC 270	HI-HC 358
Certified heating power, Air temp 26° C, Water temp 26° C	6.6 kW	8.5 kW	10.6 kW	13.2 kW	15 kW	17.7 kW	20.4 kW	27.3 kW	27.0 kW	35.8 kW
Certified heating power, Air temp 15° C, Water temp 26° C •	5.0 kW	6.2 kW	7.5 kW	9.0 kW	10.5 kW	12.0 kW	14.0 kW	18.0 kW	18.0 kW	24.5 kW
Certified cooling power, Air temp 35° C, Water temp 28° C	3.0 kW	4.0 kW	4.5 kW	5.5 kW	6.8 kW	7.7 kW	9.8 kW	12.1 kW	12.1 kW	16.4 kW
Operating temperature range	from 0°C to 43°C									
max/min power consumed (kW)	0.13~1.11	0.17~1.24	0.19~1.56	0.24~1.87	0.27~2.28	0.31~2.67	0.38~3.30	0.57~3.75	0.53~3.75	0.62~5.20
Type of refrigerant	R 32									
Recommended water flow rate	2~4 m³/h	2~4 m³/h	3~4 m³/h	4~6 m³/h	5~7 m³/h	6.5~8.5	8~10 m³/h	10~12 m³/h	10~12 m³/h	10~18 m³/h
Maximum current consumed	6.5 A	7.5 A	8.5 A	10.5 A	11 A	13 A	17 A	20 A	7 A	9.5 A
Power supply	230 V 1ph								400 V 3ph	
Power cable cross section	3x1.5 mm²		3x2.5 mm²				3x4 mm²	3x6 mm²	5x2.5 mm²	
Electrical protection	8 A	9 A	10.5 A	13 A	13.5 A	16 A	21 A	24 A	9 A	12 A
Exchanger model	Twisted. titanium coil									
Compressor	Double rotary									
Number of fans	1									
Inlet/ Outlet unions	50 mm female solvent									
Cabinet	Aluminium									
Dimension L x D x H (mm)	894x349x648			954x349x648		954x429 x648	954x429 x755	1084x429 x948		1154x539 x948
Weight	42 kg	45 kg	49 kg	50 kg	52 kg	63 kg	68 kg	90 kg	93 kg	120 kg
Code	125252276	125252277	125252278	125252279	125252280	125252281	125252282	125252283	125252284	125252285
Price	1,292.00	1,596.00	1,933.00	2,394.00	2,760.00	3,095.00	3,526.00	4,633.00	4,633.00	6,020.00

* The power output and COP, at 15°C, were certified by TÜV Rheinland in accordance with the European standard EN 15411-2011 and DTP no. 10 issued by the "Fédération des Professionnels de la Piscine (F.P.P.)" (French federation of pool professionals). The acoustic power was tested and certified by the CVC in accordance with the European standard EN 12102 dated 2008 and also DTP no. 10 issued by the Fédération des Professionnels de la Piscine (F.P.P.). Power output and acoustic power test reports for all Fairland Inverter Plus heat pumps are on procopi.com

Selecting the right heat pump is a complicated process, many factors need to be taken into consideration (location, period of use, desired temperature, etc.). To correctly size your heat pump, carry out a heating study on www.procopi.com



The AFNOR ACP 90-327 agreement and the test standard drawn up by CERTITA, in the context of NF Pool-heat pump certification, recommend communication of the heating capacity at an outdoor temperature of 15°C.



DIMENSIONS

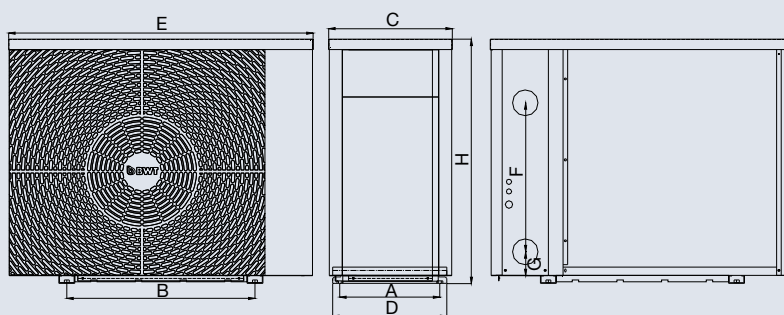

	A	B	C	D	E	F	G	H
HI-HC 66	334	590	318	359	894	250	74	648
HI-HC 85	334	590	318	359	894	250	74	648
HI-HC 106	334	590	318	359	894	280	74	648
HI-HC 132	334	590	318	359	954	340	74	648
HI-HC 150	334	590	318	359	954	340	74	648
HI-HC 177	404	590	388	429	954	390	74	648
HI-HC 204	404	590	388	429	954	460	74	755
HI-HC 273	404	720	388	429	1084	620	74	948
HI-HC 270	404	720	388	429	1084	620	74	948
HI-HC 358	514	790	498	539	1154	650	74	948

PERFORMANCE DATA - BWT INVERTER HORIZONTAL

Family 5355

Air 15°C – Water 26°C – Humidity 80%		HI-HC 66	HI-HC 85	HI-HC 106	HI-HC 132	HI-HC 150	HI-HC 177	HI-HC 204	HI-HC 273	HI-HC 270	HI-HC 358
20 % capacity	COP	14.7	14.8	15.0	15.4	15.5	15.8	15.3	15.4	15.3	15.6
100 % capacity	COP	6.0	7.4	7.4	7.3	6.7	6.2	6.0	6.5	6.5	5.8

Air 15°C – Water 26°C – Humidity 70%		HI-HC 66	HI-HC 85	HI-HC 106	HI-HC 132	HI-HC 150	HI-HC 177	HI-HC 204	HI-HC 273	HI-HC 270	HI-HC 358
20% capacity	COP	7.3	7.4	7.7	7.7	7.8	7.8	7.7	8.1	8.1	8.0
	Acoustic pressure level at 10 m, in dB (Lp)	17.8	18.8	18.6	22.1	21.3	23.1	20.9	23.5	23.5	22.6
	Acoustic power at 1m, in dB (Lw)	51.6	52.6	52.4	55.9	55.1	56.9	55.7	58.3	43.5	57.4
100% capacity	COP	4.5	5.0	4.8	4.8	4.6	4.5	4.4	4.8	4.8	4.7
	Acoustic pressure level at 10 m, in dB (Lp)	27.2	28.2	29.9	30.7	35	33.8	34.2	34.9	34.9	34.7
	Acoustic power at 1m, in dB (Lw)	61	62	63.7	64.5	68.8	67.6	69	69.7	54.9	69.5

The table above shows examples of the BWT Inverter horizontal performance levels in 3 operating modes. BWT Inverter horizontal heat pumps will automatically select the operating mode best suited to the pool's demands based on climatic conditions and operating conditions. The compressor speed is altered in steps of 1Hz between 20 Hz and 80 Hz.

HEATING & DEHUMIDIFICATION



Digital control pad



+ Vibration damping pads are not included

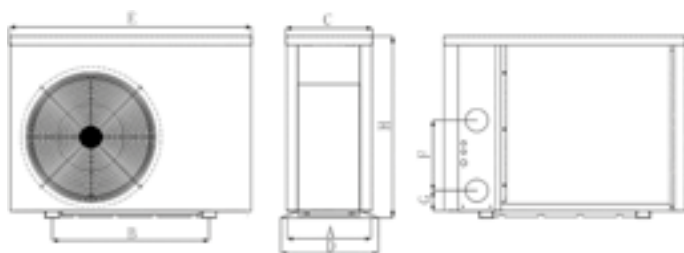

	Dimensions (cm)							
	A	B	C	D	E	F	G	H
CPIR08	324	560	308	349	864	250	74	648
CPIR10	324	560	308	349	864	250	74	648
CPIR13	324	560	308	349	864	290	74	648
CPIR17	324	590	308	349	954	350	74	648
CPIR21	324	590	308	349	954	390	74	748

Comprehensive range

The BWT Pioneer Inverter range offers a selection of models to suit pools between 18 and 95 m³. It runs in heating mode only.

Inverter system

On the contrary to a conventional On/Off heat pump that run at a constant speed (100%), the Inverter heat pump compressor can run at between 25% and 100% to adapt to the machine's operating conditions and outdoor temperatures.

BWT Pioneer Inverter heat pumps have two heating modes (smart and silence). These heat pumps automatically adjust their compressor speed to adapt to the selected operating mode and outdoor temperature.

Silence

Conventional On/Off heat pumps generate a constant sound power, even when water temperature is around the set point.

On the other hand, BWT Pioneer Inverter heat pump compressors slow significantly around the set point so that they run much more quietly than a conventional On/Off machine.

This is particularly important when the heat pump must be installed close to neighbouring properties.

Guarantees

BWT Pioneer Inverter heat pump titanium exchangers are covered by a five year guarantee, the compressor is covered by a five year guarantee.

Repairs made under this guarantee are carried out in the factory.

However, an on-site guarantee is available as an option for the duration of the 2 year guarantee (not including the compressor).

+ **The R32 refrigerant offers numerous advantages:**

- It outperforms the R410A refrigerant by 5% to 10%
- Requires less fluid for an identical output power (20 to 30% less fluid compared to R410A)
- It is more environmentally friendly. R32 has a Global Warming Potential (GWP- indicates the impact a fluid has on global warming) of 675, compared to 2088 for R410A.
- Given its low GWP, leaktightness tests are only mandatory for loads greater than 7.2 kg (compared to 2.82 kg for R410C and 2.39 kg for R410A)
- R32 is totally pure and therefore, very easy to recycle

PERFORMANCE DATA - BWT PIONEER INVERTER

Family 5350

	CPIR08	CPIR10	CPIR13	CPIR17	CPIR21
Operating temperature range (°C)	7~43				
Heating power: Air 26°C, Water 26°C					
Power output (kW)	8.0	9.5	12.5	16.5	20.0
C.O.P	9.1~5.6	9.5~5.7	10.5~5.9	10.0~5.7	10.6~5.6
C.O.P at 50% speed	8.0	8.3	9.2	8.8	8.9
Certified heating power: Air 15°C, Water 26°C					
Power output (kW)	6.0	7.0	9.0	11.5	14.0
C.O.P	5.9~4.1	6.0~4.3	5.9~4.2	6.0~4.2	6.0~4.1
C.O.P at 50% speed	5.9	5.6	5.8	6.0	5.8
Nominal power (kW)	1.4	1.6	2	2.7	3.4
Nominal input current (A)	9.5	11.5	15.0	18.0	23.0
Power cable cross section (mm ²)	3×1.5	3×2.5	3×2.5	3×4	3×4
Power supply	220~240 V / 1ph / 50 Hz				
Recommended water flow rate (m ³ / h)	2 to 4	3 to 4	4 to 6	6 to 8	8 to 10
Acoustic pressure at 1m dB (A)	40.8 / 51.1	40.6 / 52.5	42.9 / 53.0	45.2 / 56.3	45.3 / 57.1
Sound pressure, 50 % capacity at 1m dB (A)	43.9	45.8	48.5	48.7	49.6
Acoustic pressure level at 10 m dB (A)	20.8 / 31.1	20.6 / 32.5	22.9 / 33.0	25.2 / 36.3	25.3 / 37.1
Exchanger	Titanium				
Cabinet	Plastic coated metallic casing				
Nominal input power, air 15 ° C (kW)	0.34~1.4	0.35~1.6	0.36~2.1	0.57~2.7	0.62~3.4
Nominal input current, air 15 ° C (A)	1.48~6.0	1.52~7.0	1.57~8.7	2.48~11.7	2.7~15.0
Maximum input current (A)	8.0	9.5	12.5	15.0	19.5
Inlet/ outlet unions (mm)	50				
Dimensions LxDxH (mm)	864×359×648	864×359×648	864×359×648	954×359×648	954×359×748
Net weight/ gross weight (kg)	46	47	49	60	68
Code	7722000	7723000	7724000	7726000	7728000
Price	1,402.00	1,685.00	2,241.00	2,667.00	3,117.00

Selecting the right heat pump is a complicated process, many factors need to be taken into consideration (location, period of use, desired temperature, etc.). To correctly size your heat pump, carry out a heating study on www.procopi.com

BWT Pioneer Inverter





+ A ceramic coating to ensure that your heat pump keeps its looks.

BWT heat pumps are coated with an additional, protective ceramic coating. Water-repellent and UV stable, it prevents oxidation and staining by dirt or chemicals. Well protected, BWT heat pumps are easy to clean, and remain gleaming, smooth and beautiful for a very long time.

Defrosting by cycle inversion:
Allows the pump to operate at very low temperatures (down to 0° C). Cycle inversion melts frost that builds up on the evaporator much more efficiently than other defrosting methods (stopping the compressor, etc.).

Casing:
A modern innovative design made of durable, corrosion-proof aluminium.

Guarantees:
BWT Inverter vertical heat pumps are covered by life time guarantee on the titanium exchanger and 2 year guarantees on the compressor and other components. This guarantee covers repairs carried out in the factory.
An additional 2 year guarantee covering repairs on site is available as an option (excluding the compressor).

Accessory free of charge:
Protective winterizing jacket.

+ BWT vertical fan heat pumps are particularly suited to situations where the machine must be installed close to a wall, or some other obstacle, that could impede air flow causing it to be recycled through the heat pump. BWT Inverter vertical fan heat pumps are also recommended if the air expelled by the machine could cause discomfort to bathers or neighbours.

	VI-HC 135	VI-HC 175	VI-HC 210	VI-HC 300
Heating power, Air temp 26° C, Water temp 26° C	13.5 kW	17.5 kW	21.0 kW	30.0 kW
Certified heating power, Air temp 15° C, Water temp 26° C	10.0 kW	12.5 kW	15.5 kW	20.0 kW
Certified heating power, Air temp 35° C, Water temp 28° C	7.5 kW	8.5 kW	11.2 kW	14.5 kW
Recommended pool water volume (m ³)	22~55	35~65	40~75	50~95
Max/min power consumed (kW)	0.41~1.89	0.50~2.48	0.61~3.29	0.85~4.25
Operating temperature range	from 0° C to 43° C			
Type of refrigerant	R 32			
Recommended water flow rate	4~6 m ³ /h	6~8 m ³ /h	8~10 m ³ /h	10~12 m ³ /h
Maximum current consumed	12.5 A	15 A	19.5 A	19.5 A
Power supply	230 V 1ph			
Power cable cross section	3×2.5 mm ²	3×4 mm ²	3×4 mm ²	3×4 mm ²
Electrical protection	15 A	18 A	23 A	23 A
Exchanger model	Twisted coil, in PVC			
Compressor	Rotary			
Number of fans	1			
Inlet/ Outlet unions	50 mm female solvent			
Cabinet	Aluminium			
Dimension L x D x H (mm)	776×687×656	776×687×656	776×687×755	776×687×755
Weight	65 kg	72 kg	88 kg	95 kg
Code	125252286	125252287	125252288	125252289
Price	2,515.00	3,355.00	3,814.00	4,995.00

Selecting the right heat pump is a complicated process, many factors need to be taken into consideration (location, period of use, desired temperature, etc.). To correctly size your heat pump, carry out a heating study on www.procopi.com



1

The evaporator should be inspected and cleaned at regular intervals.

The build-up of dirt (grease, pollution, etc.) on the dehumidifier or heat pump evaporator fins significantly reduces heat exchange.

For example, dirt on the evaporator fins causing a 5°C increase of the condensation temperature will lead to an approximately 7% loss of the thermodynamic system's power and a 16% increase in electrical consumption.

Dirt on the evaporator can decrease heat exchange to the point that the evaporator becomes encased in ice.



HEAT PUMP ACCESSORIES

Family 5350

Code	Description	Price
Common heat pump accessories		
1	11900770 Spray for cleaning evaporateurs, 1 L	17.70
2	11900750 Universal, vibration damping mounting unit (600×180×95 mm)	per pair 128.20
Accessories		
3	11908040 Option- Inverter MPI and MZI remote control (20m cable)	256.00
	7880650 Option - IPHCR and CPIR heat pump remote control (10 m cable)	276.00
Accessories Fairland - horizontal		
4	7802022 Set of 4 vibration damping pads for Fairland heat pumps PH18L to PH80Ls	33.70

