



RFTC-50/G

Wireless temperature controller



Contents

Warning	3
Characteristics	4
Technical parameters	5
Battery replacement	6
Description of device	7
Description of display	8
Description of control.....	9
Selecting the heating mode.....	10
Setting the temperature for manual mode	11
Entering the programming menu.....	12
Entering the settings menu.....	14
Example of programming the RFTC-50/G	18

Warning

Instruction manual is designated for mounting and also for user of the device. It is always a part of its packing. Installation and connection can be carried out only by a person with adequate professional qualification upon understanding this instruction manual and functions of the device, and while observing all valid regulations. Trouble-free function of the device also depends on transportation, storing and handling. In case you notice any sign of damage, deformation, malfunction or missing part, do not install this device and return it to its seller. It is necessary to treat this product and its parts as electronic waste after its lifetime is terminated. Before starting installation, make sure that all wires, connected parts or terminals are de-energized. While mounting and servicing observe safety regulations, norms, directives and professional, and export regulations for working with electrical devices. Do not touch parts of the device that are energized - life threat. Due to transmissivity of RF signal, observe correct location of RF components in a building where the installation is taking place. RF

Control is designated only for mounting in interiors. Devices are not designated for installation into exteriors and humid spaces. The must not be installed into metal switchboards and into plastic switchboards with metal door - transmissivity of RF signal is then impossible, do not use in areas affected by high-frequency interference. RF Control is not recommended for pulleys etc. - radiofrequency signal can be shielded by an obstruction, interfered, battery of the transceiver can get flat etc. and thus disable remote control.

Characteristics

- the temperature controller RFTC-50/G is used as a simple solution for controlling temperature in a room or the home
- the RFTC-50/G is a programmable temperature controller with the option of setting a weekly program, which offers two regulation options:
 - a) the internal sensor scans the temperature, and based on the set command, it gives the command to switch on the switching actuator RFSA-6x, RFUS-61 or RFSC-61. This can be used mainly to control temperature of heaters, hall panels, convection heaters, etc.
 - b) the internal sensor scans the temperature, and based on the set command (weekly program), it switches on the actuator RFSTI-11B, which also scans the critical floor temperature (this occurs to prevent damage when opening a window). This solution is especially suitable for underfloor heating.
- control is performed using buttons, individual symbols (temperature, battery, mode, etc.) are displayed on a backlit LCD display
- the controller is powered by: batteries - 2 x AAA 1.5 V
- the flat rear side of the device enables its placement anywhere in the room where you wish to measure temperature
- the LOGUS⁹⁰ frame design offers a luxurious design (glass, wood, stone, metal) with the option of placing it in multiple frames

Technical parameters

Supply voltage:	2 x 1.5V bat. AAA
Battery life:	up to 1 year (depending on number of controlled actuators)
Temperature offset:	2 buttons v / ^
Temperature offset range:	± 5 °C
Display:	LCD, characters
Backlight:	Yes, active - blue
Transmission / function indicator:	symbols
Temperature measurement input:	1x internal sensor
Temp. meas. range and accuracy:	0 .. + 55 °C; 0.3 °C of scale
Frequency:	866 MHz, 868 MHz, 916 MHz
Signal transmission method:	bidirectionally addressed message
Minimum control distance:	20 mm
Range in open area:	up to 100 m

Other data

Max. number of controlled actuators RFSA-6x:	4
Operating temperature:	0 .. + 55 °C
Operating position:	wall
Mounting:	gluing / screwing
Protection:	IP20
Electromagnetic radiation degree:	2

Dimensions

Frame - plastic:	85 x 85 x 20 mm
Frame - metal, glass, wood, granite:	94 x 94 x 20 mm
Weight:	66 g (without batteries)
Related standards:	EN 60669, EN 300 220, EN 301 489 directive R&TTE Directive, Order. No 426/2000 Coll. (Directive 1999/EC)

Battery replacement

Prior to first assembly, remove the moldings in the frame and peel off the protective film from the display.

After inserting the batteries, all features for controlling the display function illuminate for 2 seconds, then the FW version is displayed in the upper row.

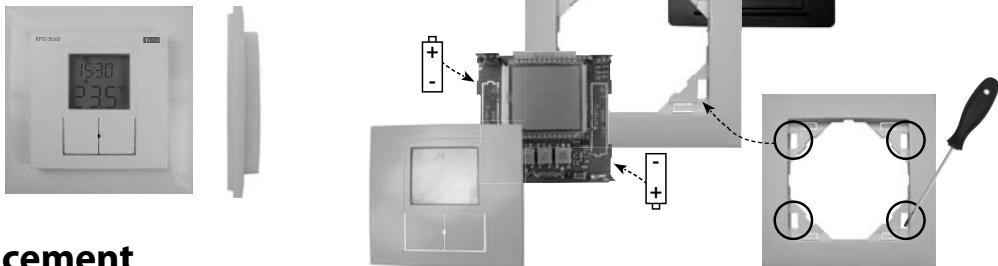

Placement

Do not expose it to sharp temperature changes, direct sunlight or excessive moisture. Place the temperature units so that they are not near windows or heating equipment, etc., which could influence the internal temperature sensor.

Attention:

When you instal iNELS RF Control system, you have to keep minimal distance 1 cm between each units.

Between the individual commands must be an interval of at least 1s.

Description of device

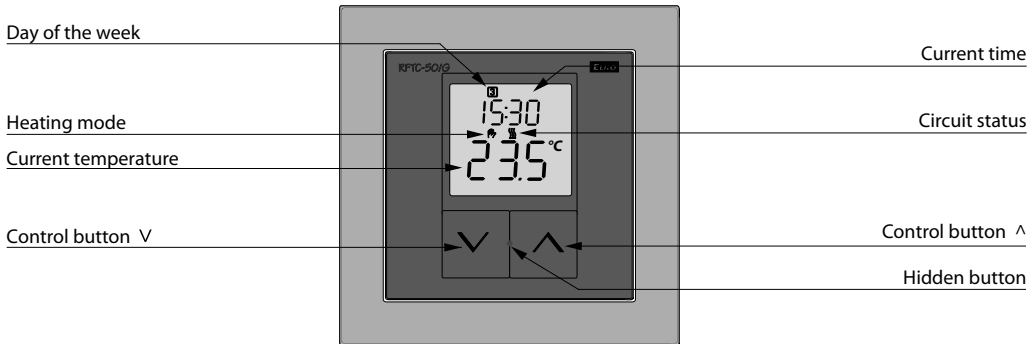

E
N

Description of display

Display of the day of the week

Automatic mode

🕒 - setting the time

🔒 - locking the menu item or program

👉 - manual mode

🌡 - setting the temperature

🔥 - output switched on when selecting heating function

❄ - output switched on when selecting cooling function

🔋 - displays in the case of low battery voltage

📅 - vacation mode

📶 - constantly illuminated - connection with all actuators successful

📶 - flashing - connection successful only with certain actuators

📶 - not illuminated - connection unsuccessful with all actuators

Mode switched off - not illuminated **Auto**, 👉, 📅

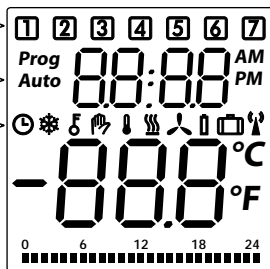

Current time
in selected
format 12/24

Battery status indicator:

A symbol 🔋 is displayed when the batteries are running low. The dead battery indicator shows that the voltage is insufficient for reliable communication with a paired actuator(s).

Description of control

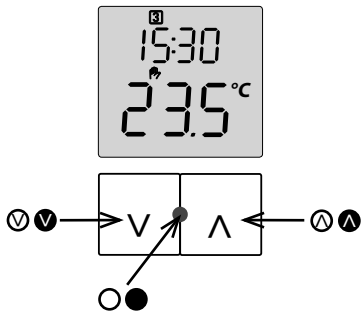

Button functions for controlling:

Short press of buttons ∇ / \wedge (< 2 s)
- switching menu items, changing value

Long button press \wedge (> 2 s)
- unlocking the menu item or time program for changing
- confirmation of changed value after setting and locking δ of the menu item or program

Long button press ∇ (> 2 s)
- refusal of changed value, return to original value and locking δ of the menu item or program

Short press of hidden button \bigcirc (< 2 s)
- closing menu - after closing the menu communication with actuators is performed
- the default display indicates the update of the actuator status (e.g. upon actuator power failure)

Long press of hidden button \bullet (> 2 s)
- upon default display entry to the menu

Selecting the heating mode

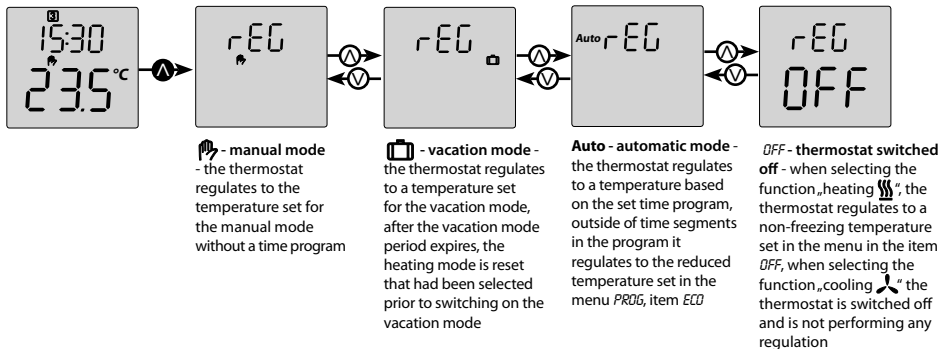

At the default display, press and hold the button **▲**. In the upper row of the display, the indicator *REG* appears and the symbol of the currently chosen heating mode flashes, or the indicator *OFF* appears. Now by shortly pressing the buttons **▼**/**▲** you can select the heating mode. Confirm the heating mode selection by pressing and holding the button **▲**. You can return to the original mode by pressing and holding **▼**. This also brings you to the initial display.

Setting the temperature for manual mode



At the default display, briefly press the button \uparrow or \downarrow . In the upper row, the indication $T\ ^{\circ}\text{C}$ is displayed and in the lower row the current selected temperature flashes.

By short presses of the buttons \downarrow / \uparrow , you will change the value by an increment of $0.5\ ^{\circ}\text{C}$.

By pressing and holding the buttons \downarrow / \uparrow , you begin accelerated setting of the value.

After completing the settings, after 5 seconds it automatically returns to the initial display, thereby confirming the temperature change. It also assesses the current and required temperatures and communicates with the actuator(s).

Entering the programming menu

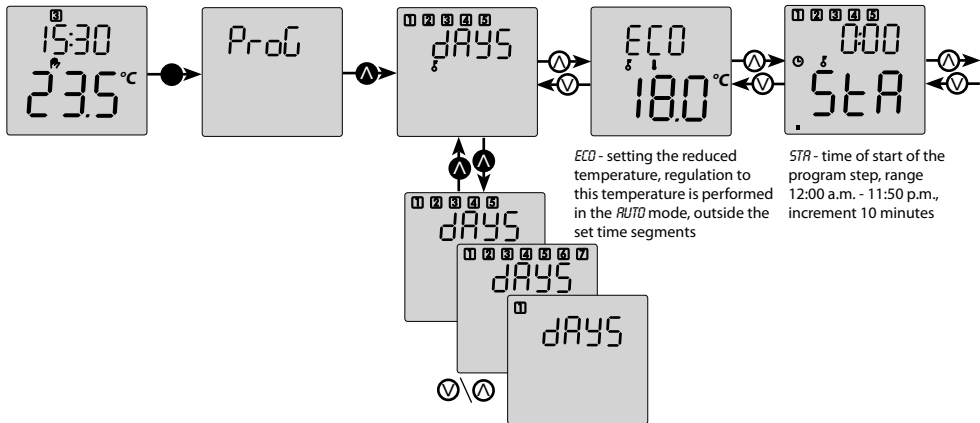

ECO - setting the reduced temperature, regulation to this temperature is performed in the *AUTO* mode, outside the set time segments

STA - time of start of the program step, range 12:00 a.m. - 11:50 p.m., increment 10 minutes

- DAYS* - setting the type of time program, selections:
- each day separately - 1
 - working day / weekend - 1 2 3 4 5
 - each day the same - 1 2 3 4 5 6 7

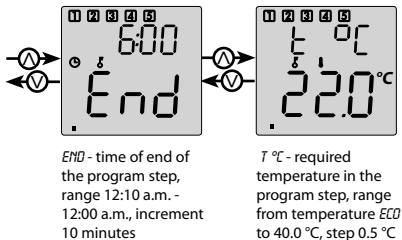

- only possible from the default display by pressing and holding the hidden button ●
- the display indicates *PROG*
- by short presses of the buttons $\odot \setminus \triangle$, you can toggle between display *PROG* and *SET*
- by pressing and holding the button \triangle you select entry into the setting of time programs (*PROG*) or into the menu (*SET*)

The programming step number is indicated on the lower bar graph by the number of displayed lines (1-6). The day of the week for which the given program step is set is displayed in the upper corner of the display.

If the program type „working day / weekend“ is selected, then for working days the symbols „1“, „2“, „3“, „4“, „5“ are displayed, and for the weekend „6“, „7“.

If the program type „every day the same“ is displayed, then for working days the symbols „1“, „2“, „3“, „4“, „5“, „6“ and „7“ are displayed.

If a programming step is to remain unused, dashes are set in the item *STR*.

Entering the settings menu

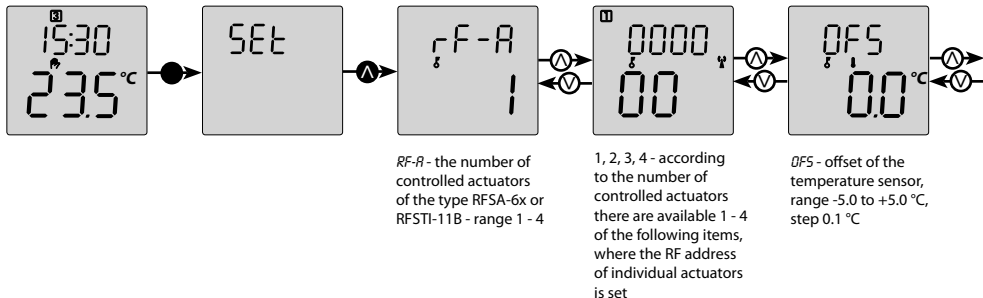

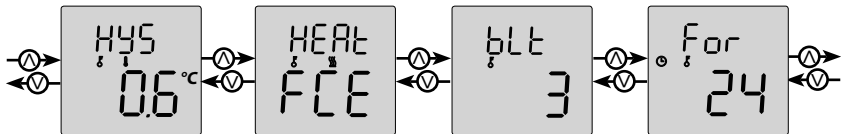

HYS - setting the hysteresis of heating / cooling, range 0.2 to 5.0 °C, step 0.2 °C

BLT - intensity of display back lighting OFF, 1 - 10

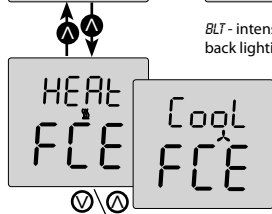

FCE - selection of function heating / cooling (*HEAT* / *COOL*) - on the upper row, the function is selected (*HEAT* / *COOL*), and on the lower row there is the name of the menu item (*FCE*)

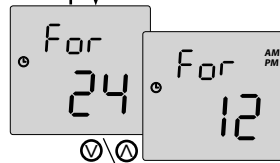

FDR - format the time display 12/24

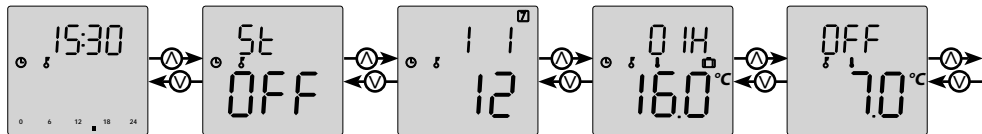

setting the time - first hours are set followed by minutes - upon confirmation of the value, the hidden second timer is zeroed out

ST - transition of summer winter time (daylight savings time) *

1112 - setting data - first the year is set (range 12 - 99, meaning 2012 - 2099), then the month followed by the day - the day of the week is set automatically according to the entered data

setting the temperature and time for vacation mode **

OFF - setting the non-freezing temperature for the OFF mode, range 6-20 °C

* OFF - switched off

The set value means a shift in local time (time zone) against UTC, range -1 to +2 (covers the countries in the EU). For EU countries it is valid that the time shift always occurs at 1:00 UTC, it is thus necessary to know the time zone to find out at what time in local time the winter and summer daylight savings time shifts are to occur.

** In the upper row, the period of vacation timer is shown in hours or days, and the lower row indicates the required temperature. By pressing and holding **▲** you unlock the temperature to settings and by short presses of the buttons **▼**/**▲** you set the required temperature. By pressing and holding the button **▲** you confirm the set temperature while switching into the setting of the time range of the vacation timer - days or hours - and further units and tens of days or hours.

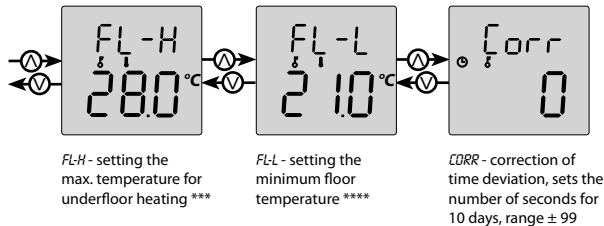

*** *OFF* - floor temperature function is switched off, the actuator(s) of the type RFSa-6x is(are) controlled. Range 20 - 35 °C, floor temperature function is switched on, the actuator(s) of the type RFSTI-11B is(are) controlled (with date of manufacture from 03/2013).

**** Used for tempering the floor when using a different heating source.
OFF - the function for maintaining the minimum floor temperature is switched off.
 Range 20 °C up to the max. set floor temperature (*FL-H*).

Example of programming the RFTC-50/G

Example of settings for actuator RFSA-6x, RFSC-61, RFUS-61 and RFSTI-11B

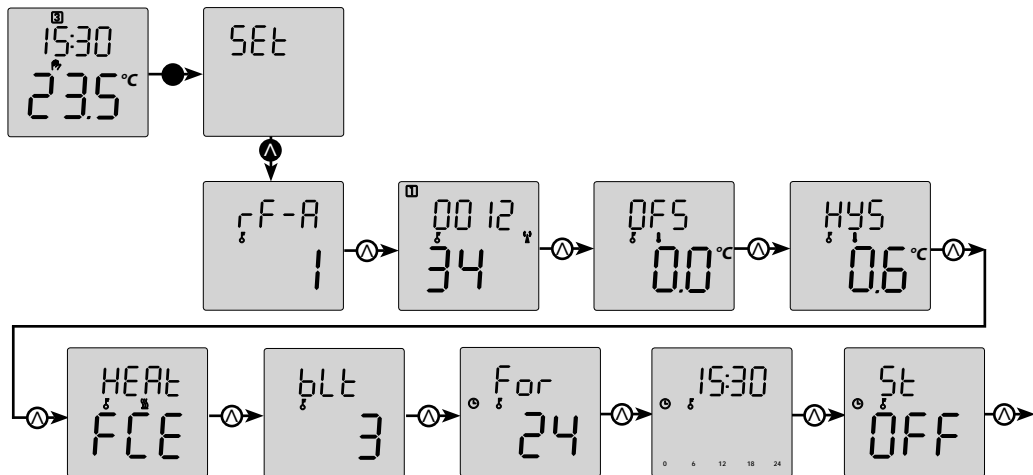

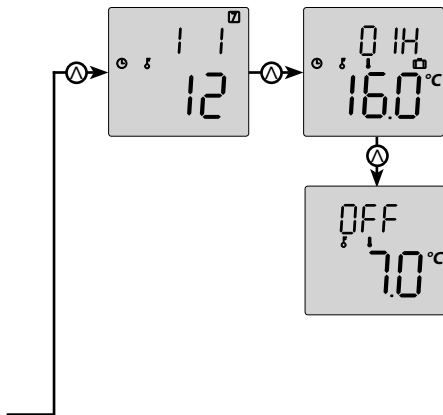

Example for 1 actuator type RFSTI-11B with RF address 001234 with hysteresis of 0.6 °C, heating function, time format 24 hr., daylight savings time switched off, non-freezing temperature set to 7 °C, maximum floor temperature 28 °C, minimum floor temperature 21 °C, time correction 0.

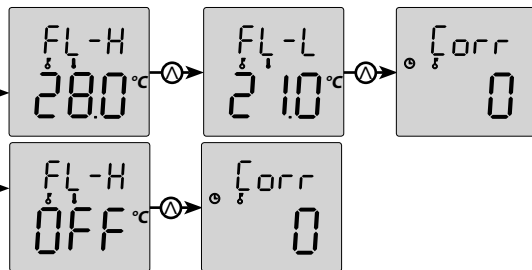

Example of settings for 1 actuator type RFSA-6x with RF address 001234 with hysteresis of 0.6 °C, heating function, time format 24 hr., daylight savings time switched off, non-freezing temperature set to 7 °C, time correction 0.